

# Accessories



More than just pumps

Accessories for

- ▶ drum and container pumps
- ▶ eccentric worm-drive pumps
- ▶ motors

Tailor-made products, intelligent solutions, comprehensive service and certified safety are the characteristic features of the versatile FLUX pump technology. With FLUX, you can rely on more than 60 years of competence highly appreciated all over the world. The special quality of the products and their long life guarantee process and operational reliability and prevent downtime costs.

**The FLUX range of products includes:**

- ▶ drum pumps
- ▶ eccentric worm-drive pumps
- ▶ centrifugal immersion pumps
- ▶ air-operated diaphragm pumps
- ▶ flow meters
- ▶ mixers
- ▶ complete system solutions
- ▶ extensive range of accessories



We offer an extensive range of accessories to supplement our large variety of drum, container and eccentric worm-drive pumps. We would like to present some of the especially interesting products beforehand.

FLUX offers solutions for the most varied types of industries and their special requirements.

## FLUX FOOD pumps

The pumps of the FLUX FOOD series and their accessories meet the latest European safety standards for food contact. They comply with Regulation (EC) No. 1935/2004 and the „Plastics“ Regulation (EU) 10/2011 and are allowed to bear the glass-fork symbol. Moreover, they meet the requirements of the U.S. Food and Drug Administration (FDA).



## FLUX hand nozzles



# Graphical overview of pump accessories

- for use in hazardous areas
- for use in not hazardous areas
- for use in hazardous and not hazardous areas

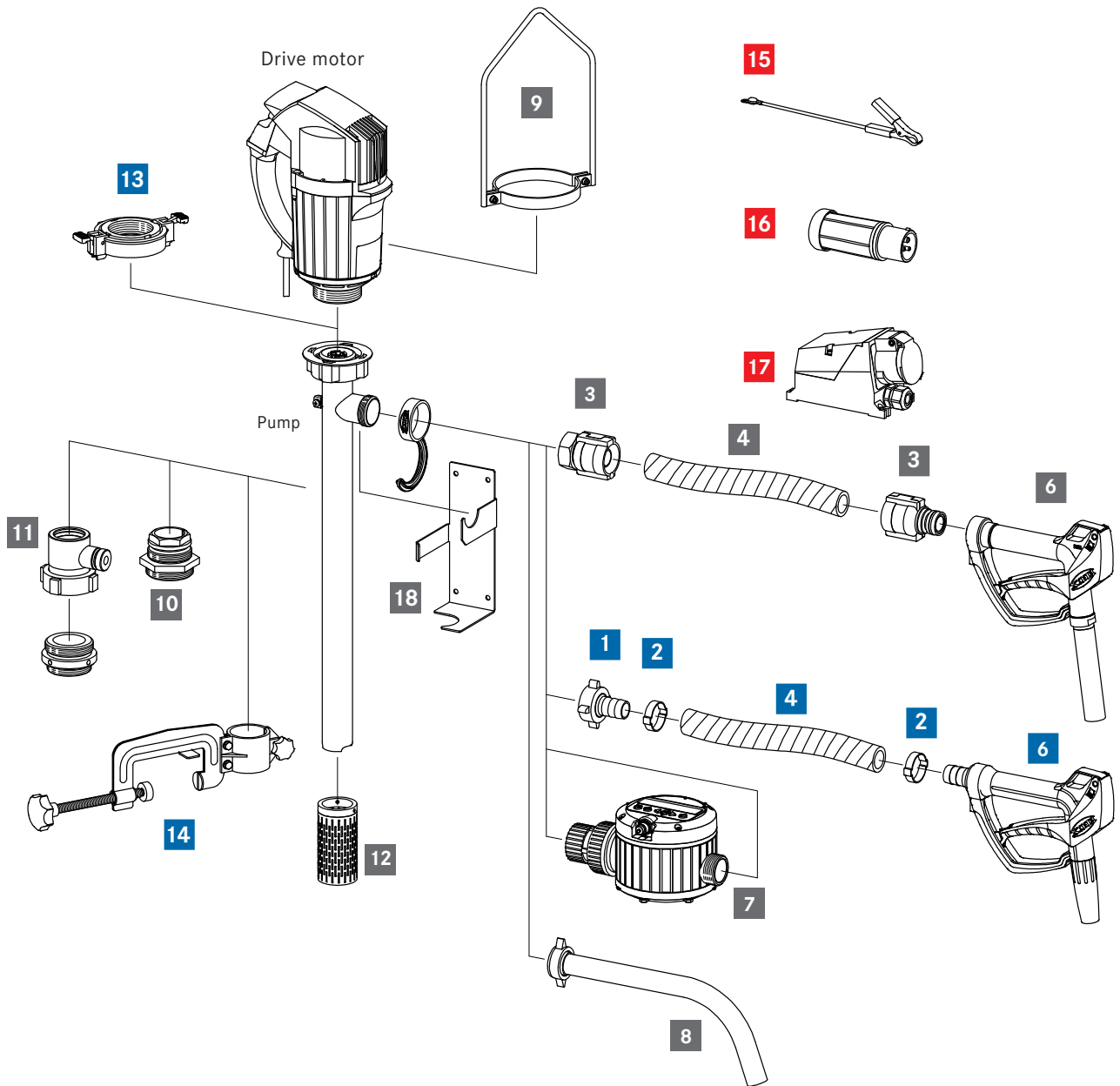

	Page		Page
<b>1</b> Hose connection	6	<b>10</b> Compression gland	14
<b>2</b> Hose clip	7	<b>11</b> FLUX fume gland	15
<b>3</b> Swaged hose fitting	9, 10	<b>12</b> Suction strainer	16
<b>4</b> Hose	11	<b>13</b> Quick action coupling	14
<b>5</b> Hose kit (3+4 = hose kit)	8	<b>14</b> Attachment clamp	17
<b>6</b> Hand nozzle	12, 13	<b>15</b> Earth (ground) wire	18
<b>7</b> Flow meters	XX	<b>16</b> Explosion-proof plug	19
<b>8</b> Discharge spout	16	<b>17</b> Explosion-proof socket	19
<b>9</b> Carrying handle	17	<b>18</b> Wall bracket	17

<b>Hose connections</b>	<b>6</b>
<b>Hose clips</b>	<b>7</b>
<b>Hose kits</b>	<b>8</b>
<b>Swaged hose fittings</b>	<b>9 – 10</b>
<b>Hoses</b>	<b>11</b>
<b>Hand nozzles</b>	<b>12 – 13</b>
<b>Other pump accessories</b>	
Drum adapter	<b>14</b>
Compression gland	
Quick action coupling	
Mixing tube	
Fume gland	<b>15</b>
Fume cone	
Other accessories	
Discharge spout	<b>16</b>
Suction strainer	
Inliner suction protection	
Flowback stop valve	
By-pass valve	
Attachment clamp	<b>17</b>
Container clip	
Mounting flange	
Wall bracket	
Hoist	
Carrying handle	
<b>Accessories for drive motors</b>	
Earth wire	<b>18</b>
Motor protection switches	
Power supply cables	
Cekon plug	
Explosion-proof plugs	<b>19</b>
Explosion-proof sockets	
Filter-regulator-lubricator unit	
Fine filter sound absorber	
Exhaust air hose kit for fine filter	
Pressure regulator	
<b>Accessories for FOOD version</b>	<b>20</b>
Hose connections	
Swaged hose fitting	
Discharge spout	
Flap valve	
Hand nozzle	

# Hose connections

## Hose connection consisting of: union nut, hose connector and seal.

Suitable for PVC hoses, petroleum hose and special food-grade hose.

weight metal version: DN 19 ~ 0,02 kg, DN 32 ~ 0,05 kg

weight PP + PVDF version: DN 19 ~ 0,01 kg, DN 32 ~ 0,02 kg

- material: **stainless steel**, with union nut in brass, **nickel-plated** G 1¼ female

nominal Ø	part no.
DN 19	10-959 04 061
DN 25	10-959 04 041
DN 32	10-959 04 042

- material: **stainless steel**, with union nut in **stainless steel** G 1¼ female

nominal Ø	part no.
DN 19	10-959 04 062
DN 25	10-959 04 063
DN 32	10-959 04 064

- material: **aluminium**, with union nut in brass, **nickel plated** G 1¼ female

nominal Ø	part no.
DN 19	10-959 04 050
DN 25	10-959 04 039
DN 32	10-959 04 040

- material: **hastelloy C**, with union nut in **stainless steel** G 1¼ female

nominal Ø	part no.
DN 25	10-959 04 043
DN 32	10-959 04 044

- material: **polypropylene**, with union nut G 1¼ female

nominal Ø	part no.
DN 13	10-959 04 081
DN 19	10-959 04 053
DN 25	10-959 04 052
DN 32	10-959 04 054

- material: **polyvinylidene fluoride**, with union nut G 1¼ female

nominal Ø	part no.
DN 13	10-959 04 082
DN 19	10-959 04 101
DN 25	10-959 04 102
DN 32	10-959 04 103



## Hose connections for eccentric worm-drive pumps with union nut or clamp connection.

- Material: **stainless steel**

weight: DN 25 ~ 0,03 kg, DN 38 ~ 0,06 kg

nominal Ø	part no.
DN 25 Rd 58 x 1/6	10-959 04 115
DN 32 Rd 58 x 1/6	10-959 04 134
DN 38 Rd 58 x 1/6	10-959 04 130
DN 25 G 1½	10-959 04 002
DN 32 G 1½	10-959 04 003
DN 38 G 1½	10-959 04 004
DN 25 Clamp 2"	10-959 04 136
DN 32 Clamp 2"	10-959 04 137
DN 38 Clamp 2"	10-959 04 109



## 1-Ear hose clip

in stainless steel for use with hose connection

- for **PVC hose**

	outer-Ø	part no.
DN 13	18 mm	10-959 13 237
DN 19	27 mm	10-959 13 241
DN 25	34 mm	10-959 13 243
DN 32	41 mm	10-959 13 248
DN 38	47 mm	10-959 13 251
DN 50	60 mm	10-959 13 255

- for **petroleum hose**

	outer-Ø	part no.
DN 13	21 mm	10-959 13 239
DN 19	27 mm	10-959 13 241
DN 25	34 mm	10-959 13 243
DN 32	43 mm	10-959 13 249
DN 38	51 mm	10-959 13 252

- for **hose for food and chemistry**

	outer-Ø	part no.
DN 13	22 mm	10-959 13 239
DN 19	31 mm	10-959 13 242
DN 25	37 mm	10-959 13 246
DN 32	43 mm	10-959 13 249
DN 38	51 mm	10-959 13 252

- for **special hose for food and chemistry**

	outer-Ø	part no.
DN 19	31 mm	10-959 13 242
DN 25	37 mm	10-959 13 246
DN 32	44 mm	10-959 13 249

- for **special food-grade hose**

	outer-Ø	part no.
DN 25	37 mm	10-959 13 246
DN 38	51 mm	10-959 13 252

## Clamp forceps

	part no.
to fix 1-Ear hose clip	10-961 40 811



# Hose kits

## Hose kits suitable for brass hand nozzle

connection Ø 32 mm part no. 10-001 12 340

connection to drum pump G 1 ¼ female, electrically conductive, bracket clamp in aluminium nickel-plated

- **petroleum hose kit**

nominal-Ø	length	material hose connector	weight	part no.
DN 19	2 m	brass	2,6 kg	10-001 10 091
	3 m	brass	3,5 kg	10-001 10 092
DN 25	2 m	brass	2,6 kg	10-001 10 081
	3 m	brass	3,5 kg	10-001 10 082

hose kit

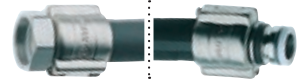

suitable for

- **universal hose kit**

nominal-Ø	length	material hose connector	weight	part no.
DN 21	2 m	brass	2,1 kg	10-001 10 839
	3 m	brass	3,0 kg	10-001 10 840



hand nozzle MS  
(see page 13)

- **hose kit for food and chemistry**

nominal-Ø	length	material hose connector	weight	part no.
DN 19	2 m	brass	2,1 kg	10-001 10 089
	3 m	brass	3,0 kg	10-001 10 090
DN 25	2 m	brass	2,3 kg	10-001 10 811
	3 m	brass	3,2 kg	10-001 10 812

## Hose kits suitable for stainless steel hand nozzle

connection Ø 28 mm part no. 10-001 12 549

connection to drum pump G 1 ¼ female, electrically conductive, bracket clamp in aluminium nickel-plated

- **universal hose kit**

nominal-Ø	length	material hose connector	weight	part no.
DN 21	2 m	stainless steel	2,6 kg	10-001 10 870
	3 m	stainless steel	2,6 kg	10-001 10 871

hose kit

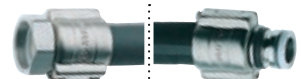

suitable for

- **hose kit for food and chemistry**

nominal-Ø	length	material hose connector	weight	part no.
DN 19	2 m	stainless steel	2,3 kg	10-001 10 873
	3 m	stainless steel	3,2 kg	10-001 10 874
DN 25	2 m	stainless steel	2,3 kg	10-001 10 868
	3 m	stainless steel	3,2 kg	10-001 10 869



hand nozzle S  
(see page 13)



## Swaged hose fittings for bonding electrically conductive hoses

for use in hazardous areas and for transferring high flammable liquids. Suitable for universal hose, hose for food and chemistry, special hose for food and chemistry

- **Swaged hose fitting for the connection of pump and hose**  
weight brass: DN 13 – G 1/2 ~ 0,17 kg, DN 38 – G 1/2 ~ 0,50 kg  
weight stainless steel: DN 13 – G 1/2 ~ 0,06 kg, DN 38 – G 1/2 ~ 0,50 kg

### Hose connector in brass

bracket clamp	seal	nominal-Ø	version	outer-Ø hose in mm	part no.
brass	PUR	DN 13 – G 1/2	HE	21	10-959 13 130
brass	PUR	DN 19 – G 1	HE	27	10-959 13 116
brass		DN 19 – G 1 A	HE	27	10-959 13 118
brass	PUR	DN 19 – G 1 1/4	HE	27	10-959 13 192
AL nickel-plated	PUR	DN 19 – G 1	SL	30 – 33	10-959 13 157
AL nickel-plated		DN 19 – G 1 A	SL	30 – 33	10-959 13 156
AL nickel-plated	PUR	DN 19 – G 1 1/4	SL	30 – 33	10-959 13 180
AL nickel-plated	PUR	DN 21 – G 1 1/4	SL	30 – 33	10-959 13 230
brass	PUR	DN 25 – G 1	HE	34	10-959 13 097
brass		DN 25 – G 1 A	HE	34	10-959 13 099
brass	PUR	DN 25 – G 1 1/4	HE	34	10-959 13 098
AL nickel-plated	PUR	DN 25 – G 1	SF	36 – 38	10-959 13 158
AL nickel-plated	PUR	DN 25 – G 1 A	SF	36 – 38	10-959 13 159
AL nickel-plated	PUR	DN 25 – G 1 1/4	SF	36 – 38	10-959 13 140
AL nickel-plated		DN 25 – G 1 1/4 A	SF	36 – 38	10-959 13 188
AL nickel-plated	PUR	DN 32 – G 1 1/4	SF	43 – 45	10-959 13 014
AL nickel-plated	PUR	DN 32 – G 1 1/2	SF	43 – 45	10-959 13 015
AL nickel-plated	PUR	DN 38 – G 1 1/2	SF	50 – 52	10-959 13 143
	PUR	G 1 1/4 – G 1 A	reducer		10-959 06 019
	PUR	G 1 1/2 – G 1 1/4 A	reducer		10-959 06 002



ferrule type with union nut (female thread) = HE Version

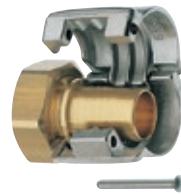

with pinned safety clamps (Spannfix) = SF Version



with bolted clamps (Spannloc) = SL Version

### Hose connector in stainless steel

bracket clamp	seal	nominal-Ø	version	outer-Ø hose in mm	part no.
AL nickel-plated	PTFE	DN 13 – G 1/2	SL	22 – 24	10-959 13 178
AL nickel-plated	PTFE	DN 19 – G 1	SL	30 – 33	10-959 13 160
AL nickel-plated	PTFE	DN 19 – G 1 1/4	SL	30 – 33	10-959 13 181
AL nickel-plated	PTFE	DN 21 – G 1 1/4	SL	30 – 33	10-959 13 231
AL nickel-plated	PTFE	DN 25 – G 1	SF	36 – 38	10-959 13 161
AL nickel-plated		DN 25 – G 1 A	SF	36 – 38	10-959 13 162
AL nickel-plated	PTFE	DN 25 – G 1 1/4	SF	36 – 38	10-959 13 144
AL nickel-plated	PTFE	DN 32 – G 1 1/4	SF	43 – 45	10-959 13 145
AL nickel-plated	PTFE	DN 32 – G 1 1/2	SF	43 – 45	10-959 13 146
AL nickel-plated	PTFE	DN 38 – G 1 1/2	SF	50 – 52	10-959 13 147
S	PTFE	G 1 1/2 – G 1 1/4 A	reducer		10-959 06 005

### Hose connector in polypropylene

bracket clamp	seal	nominal-Ø	version	outer-Ø hose in mm	part no.
AL nickel-plated	PE	DN 13 – G 1	SL	22 – 24	10-959 13 285
AL nickel-plated	PE	DN 13 – G 1 1/4	SL	22 – 24	10-959 13 289
AL nickel-plated	PE	DN 19 – G 1	SL	30 – 33	10-959 13 287
AL nickel-plated	PE	DN 19 – G 1 1/4	SL	30 – 33	10-959 13 291
AL nickel-plated	PE	DN 21 – G 1 1/4	SL	30 – 33	10-959 13 293
AL nickel-plated	PE	DN 25 – G 1 1/4	SF	36 – 38	10-959 13 295
S	PE	DN 13 – G 1	SL	22 – 24	10-959 13 317
S	PE	DN 13 – G 1 1/4	SL	22 – 24	10-959 13 321
S	PE	DN 19 – G 1	SL	30 – 33	10-959 13 319
S	PE	DN 19 – G 1 1/4	SL	30 – 33	10-959 13 323
S	PE	DN 21 – G 1 1/4	SL	30 – 33	10-959 13 325
S	PE	DN 25 – G 1 1/4	SL	36 – 39	10-959 13 327

# Swaged hose fittings

## Hose connector in polyvinylidene fluoride

bracket clamp	seal	nominal-Ø	version	outer-Ø hose in mm	part no.
AL nickel-plated	PTFE	DN 13 - G 1	SL	22 - 24	10-959 13 286
AL nickel-plated	PTFE	DN 13 - G 1¼	SL	22 - 24	10-959 13 290
AL nickel-plated	PTFE	DN 19 - G 1	SL	30 - 33	10-959 13 288
AL nickel-plated	PTFE	DN 19 - G 1¼	SL	30 - 33	10-959 13 292
AL nickel-plated	PTFE	DN 21 - G 1¼	SL	30 - 33	10-959 13 294
AL nickel-plated	PTFE	DN 25 - G 1¼	SF	36 - 38	10-959 13 296
S	PTFE	DN 13 - G 1	SL	22 - 24	10-959 13 318
S	PTFE	DN 13 - G 1¼	SL	22 - 24	10-959 13 322
S	PTFE	DN 19 - G 1	SL	30 - 33	10-959 13 320
S	PTFE	DN 19 - G 1¼	SL	30 - 33	10-959 13 324
S	PTFE	DN 21 - G 1¼	SL	30 - 33	10-959 13 326
S	PTFE	DN 25 - G 1¼	SL	36 - 39	10-959 13 328

## Swaged hose fittings for the connection of hose and hand nozzle

Connection hand nozzle Ø 28mm, hose connector: PP

bracket clamp	seal	nominal-Ø	version	outer-Ø hose in mm	part no.
AL nickel-plated	FKM	DN 19	SL	30 - 33	10-959 13 299
AL nickel-plated	EPDM	DN 19	SL	30 - 33	10-959 13 300
AL nickel-plated	FKM	DN 21	SL	30 - 33	10-959 13 304
AL nickel-plated	EPDM	DN 21	SL	30 - 33	10-959 13 305
AL nickel-plated	FKM	DN 25	SF	36 - 38	10-959 13 309
AL nickel-plated	EPDM	DN 25	SF	36 - 38	10-959 13 310
S	FKM	DN 19	SL	30 - 33	10-959 13 330
S	EPDM	DN 19	SL	30 - 33	10-959 13 331
S	FKM	DN 21	SL	30 - 33	10-959 13 335
S	EPDM	DN 21	SL	30 - 33	10-959 13 336
S	FKM	DN 25	SL	36 - 39	10-959 13 340
S	EPDM	DN 25	SL	36 - 39	10-959 13 341



suitable hand nozzle PP  
see page 12

Connection hand nozzle Ø 28mm, hose connector: PVDF

bracket clamp	seal	nominal-Ø	version	outer-Ø hose in mm	part no.
AL nickel-plated	FKM	DN 13	SL	22 - 24	10-959 13 298
AL nickel-plated	FKM	DN 19	SL	30 - 33	10-959 13 301
AL nickel-plated	EPDM	DN 19	SL	30 - 33	10-959 13 302
AL nickel-plated	FFKM	DN 19	SL	30 - 33	10-959 13 303
AL nickel-plated	FKM	DN 21	SL	30 - 33	10-959 13 306
AL nickel-plated	EPDM	DN 21	SL	30 - 33	10-959 13 307
AL nickel-plated	FFKM	DN 21	SL	30 - 33	10-959 13 308
AL nickel-plated	FKM	DN 25	SF	36 - 38	10-959 13 311
AL nickel-plated	EPDM	DN 25	SF	36 - 38	10-959 13 312
AL nickel-plated	FFKM	DN 25	SF	36 - 38	10-959 13 313
S	FKM	DN 13	SL	22 - 24	10-959 13 329
S	FKM	DN 19	SL	30 - 33	10-959 13 332
S	EPDM	DN 19	SL	30 - 33	10-959 13 333
S	FFKM	DN 19	SL	30 - 33	10-959 13 334
S	FKM	DN 21	SL	30 - 33	10-959 13 337
S	EPDM	DN 21	SL	30 - 33	10-959 13 338
S	FFKM	DN 21	SL	30 - 33	10-959 13 339
S	FKM	DN 25	SL	36 - 39	10-959 13 342
S	EPDM	DN 25	SL	36 - 39	10-959 13 343
S	FFKM	DN 25	SL	36 - 39	10-959 13 344



suitable hand nozzle PVDF  
see page 12

## Bracket clamp stainless steel ECTFE coated

for corrosion protection. With screws and nuts out of HC

nominal-Ø	part no.
DN 13	10-959 13 345
DN 19	10-959 13 346
DN 25	10-959 13 347

## Hoses without Inliner

for use with hose connections (page 6) or swaged hose fitting (page 9-10).

- **PVC hose with fabric lining**

suitable for food contact according to Regulation (EC) 1935/2004, temperature: max. +60 °C

nominal-Ø	outer-Ø	operating pressure max.	weight per meter	part no.
DN 13	20 mm	10 bar	0,22 kg	10-001 10 008

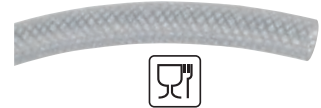

- **PVC hose with steel wire-helix**

suitable for food contact according to Regulation (EC) 1935/2004, temperature: -5 °C up to +65 °C

Nennweite	outer-Ø	operating pressure max.	weight per meter	part no.
DN 19	27 mm	5 bar	0,34 kg	10-001 10 040
DN 25	33 mm	5 bar	0,51 kg	10-001 10 041
DN 32	41 mm	4,5 bar	0,65 kg	10-001 10 042
DN 38	47 mm	4 bar	0,80 kg	10-001 10 043
DN 50	60 mm	3 bar	1,20 kg	10-001 10 044



- **Petroleum hose**

electrically conductive  $\Omega$  to EN 12115:2011, tube: NBR black, over: NBR/PVC, temperature: -30 °C up to +80 °C

nominal-Ø	outer-Ø	operating pressure max.	weight per meter	part no.
DN 13	21 mm	10 bar	0,30 kg	10-001 10 076
DN 19	27 mm	10 bar	0,40 kg	10-001 10 065
DN 25	34 mm	10 bar	0,50 kg	10-001 10 002



electrically conductive  $\Omega$ /T to EN 12115:2011, tube: NBR black, over: CR black, temperature: -30 °C up to +80 °C

nominal-Ø	outer-Ø	operating pressure max.	weight per meter	part no.
DN 32	44 mm	25 bar	1,00 kg	10-001 10 003
DN 38	51 mm	25 bar	1,20 kg	10-001 10 004

- **Special foodgrade hose**

suitable for food contact according to Regulation (EC) 1935/2004 and FDA CFR 21. tube: NBR white, cover: NBR/PVC blue, temperature: -25 °C up to +80 °C

nominal-Ø	outer-Ø	operating pressure max.	weight per meter	part no.
DN 25	37 mm	16 bar	0,80 kg	10-001 10 022
DN 38	51 mm	16 bar	1,7 kg	10-001 10 023



## Hoses with inliner

for use with swaged hose fittings (page 9-10).

- **Universal hose** electrically conductive  $\Omega$  to EN 12115:2011, tube: fluoropolymer THV seamless temperature: -40 °C up to +100 °C

nominal-Ø	outer-Ø	operating pressure max.	weight per meter	part no.
DN 21	31 mm	16 bar	0,6 kg	10-001 10 838



- **Hose for food and chemistry** electrically conductive  $\Omega$ /T to EN 12115:2011 suitable for food contact according to Regulation (EC) 1935/2004 and FDA CFR 21 tube: ultra-high molecular PE transparent, cover: EPDM black, temperature: -30 °C up to +100 °C

nominal-Ø	outer-Ø	operating pressure max.	weight per meter	part no.
DN 13	22 mm	16 bar	0,30 kg	10-001 10 085
DN 19	31 mm	16 bar	0,60 kg	10-001 10 037
DN 25	37 mm	16 bar	0,80 kg	10-001 10 030
DN 32	43 mm	16 bar	1,00 kg	10-001 10 036
DN 38	51 mm	16 bar	1,20 kg	10-001 10 086



- **Special hose for food and chemistry** electrically conductive  $\Omega$  to EN 12115:2011 suitable for food contact according to FDA CFR 21, tube: fluorine polymer white, cover: CR black, temperature: -30 °C up to +100 °C

nominal-Ø	outer-Ø	operating pressure max.	weight per meter	part no.
DN 19	31 mm	16 bar	0,80 kg	10-001 10 097
DN 25	37 mm	16 bar	1,00 kg	10-001 10 046
DN 32	44 mm	16 bar	1,30 kg	10-001 10 029



# Hand nozzles

## Hand nozzles with hose connection – for use with hoses without inliner.

- **For low volumes, material: polypropylene**, operating pressure: max. 1,5 bar, flow rate: max. 35 l/min (water), viscosity: max. 350 mPas (cP), temperature: max. 45 °C

nominal-Ø	seal	outlet	weight	part no.
DN 13	FKM	6 mm	0,11 kg	10-001 13 001
DN 13	FKM	11 mm	0,11 kg	10-001 13 034
DN 19	FKM	11 mm	0,11 kg	10-001 13 039
DN 19	FKM	20 mm	0,11 kg	10-001 13 000
DN 25	FKM	20 mm	0,11 kg	10-001 13 035

- **Material: polypropylene** with safety handle and swivel inlet, operating pressure: max. 3 bar, flow rate: max. 80 l/min (water), viscosity: max. 800 mPas (cP), temperature: max. 50 °C

nominal-Ø	seal	outlet	weight	part no.
DN 19	FKM	25 mm	0,26 kg	10-001 12 500
DN 19	EPDM	25 mm	0,26 kg	10-001 12 506
DN 25	FKM	25 mm	0,26 kg	10-001 12 504
DN 25	EPDM	25 mm	0,26 kg	10-001 12 510

- **AdBlue® Version, material: polypropylene** with safety handle and swivel inlet

nominal-Ø	seal	outlet	weight	part no.
DN 19	FKM	19 mm	0,26 kg	10-001 12 518

- **Material: polyvinylidene fluoride** with safety handle and swivel inlet; operating pressure: max. 3 bar, flow rate: max. 80 l/min (water), viscosity: max. 800 mPas (cP), temperature: max. 50 °C

nominal-Ø	seal	outlet	weight	part no.
DN 19	FKM	25 mm	0,36 kg	10-001 12 501
DN 19	EPDM	25 mm	0,36 kg	10-001 12 507
DN 19	FFKM	25 mm	0,36 kg	10-001 12 512
DN 25	FKM	25 mm	0,36 kg	10-001 12 505
DN 25	EPDM	25 mm	0,36 kg	10-001 12 511
DN 25	FFKM	25 mm	0,36 kg	10-001 12 514

- **Hand nozzle AL** with safety handle and swivel inlet (hose connector or threaded connector); suitable for solvents and neutral liquids, material: brass, nickel-plated, operating pressure: max. 4 bar, flow rate: max. 80 l/min (water), viscosity: max. 800 mPas (cP), temperature: max. 60 °C

nominal-Ø	seal	outlet	weight	part no.
DN 19	NBR	25 mm	0,50 kg	10-001 12 397
DN 25	NBR	25 mm	0,50 kg	10-001 12 172
G 1	NBR	25 mm	0,50 kg	10-001 12 171



## Hand nozzles without hose connection – for use with hoses with inliner.

Swaged hose fittings see page 9-10.

- **Material: polypropylene** with safety handle and swivel inlet operating pressure: max. 3 bar, flow rate: max. 80 l/min (water), viscosity: max. 800 mPas (cP), temperature: max. 50 °C

nominal-Ø	seal	outlet	weight	part no.
Ø 28	FKM	25 mm	0,26 kg	10-001 12 556
Ø 28	EPDM	25 mm	0,26 kg	10-001 12 557

- **Material: polyvinylidene fluoride** with safety handle and swivel inlet; operating pressure: max. 3 bar, flow rate: max. 80 l/min (water), viscosity: max. 800 mPas (cP), temperature: max. 50 °C

nominal-Ø	seal	outlet	weight	part no.
Ø 28	FKM	25 mm	0,36 kg	10-001 12 558
Ø 28	EPDM	25 mm	0,36 kg	10-001 12 559
Ø 28	FFKM	25 mm	0,36 kg	10-001 12 560



## Hand nozzle with hose connection – for use with hoses without inliner

- **Material: stainless steel 316 Ti** with safety handle and swivel inlet operating pressure: max. 4 bar, flow rate: max. 80 l/min (water), viscosity: max. 800 mPas (cP), temperature: max. 100 °C

nominal-Ø	seal	outlet Ø	weight	part no.
DN 19	PTFE/FEP	28 mm	1,4 kg	10-001 12 541
DN 25	PTFE/FEP	28 mm	1,4 kg	10-001 12 542
G 1 male	PTFE/FEP	28 mm	1,4 kg	10-001 12 543
G 1 ¼ male	PTFE/FEP	28 mm	1,4 kg	10-001 12 544



- **Hand nozzle MS** with safety handle and swivel inlet (hose connector or threaded connector); suitable for solvents and neutral liquids, **material: brass, nickel-plated**, operating pressure: max. 4 bar, flow rate: max. 80 l/min (water), viscosity: max. 900 mPas (cP), temperature: max. 80 °C

nominal-Ø	seal	outlet Ø	weight	part no.
DN 25	PTFE	25 mm	1,05 kg	10-001 12 337
DN 32	PTFE	25 mm	1,05 kg	10-001 12 338
G 1 female	PTFE	25 mm	1,05 kg	10-001 12 339
G 1 male	PTFE	25 mm	1,05 kg	10-001 12 389



## Hand nozzles without hose connection – for use with hoses with inliner.

Swaged hose fittings see page 10.

- **Material: stainless steel 316 Ti** with safety handle and swivel inlet, operating pressure: max. 4 bar, flow rate: max. 80 l/min (water), viscosity: max. 800 mPas (cP), temperature: max. 100 °C

nominal-Ø	seal	outlet Ø	weight	part no.
Ø 28	PTFE/FEP	28 mm	1,4 kg	10-001 12 549



- **Material: brass, nickel-plated** with safety handle and swivel inlet, operating pressure: max. 4 bar, flow rate: max. 80 l/min (water), viscosity: max. 900 mPas, temperature: max. 80 °C

nominal-Ø	seal	outlet Ø	weight	part no.
Ø 32	PTFE	25 mm	1,05 kg	10-001 12 340



- **Material: aluminium (AL 20)** spring actuated, with safety handle and rigid inlet (threaded connector) or swivel inlet (threaded connector); suitable for petrol, diesel oil, fuel oil, crude oil. Operating pressure: 0,5 - 4 bar, flow rate: max. 80 l/min (water), viscosity: max. 7 mPas (cP), temperature: max. 60 °C

nominal-Ø	seal	outlet Ø	weight	part no.
G 1 male	PTFE	24 mm	0,95 kg	10-001 12 109
G 1 male	PTFE	24 mm*	0,95 kg	10-001 12 335
G 1 male	NBR	24 mm**	0,95 kg	10-001 12 347

\* with swivel inlet, \*\* for use with fume cone



- **Material: aluminium (AL 20 R unleaded)** spring actuated, with safety handle and swivel inlet (threaded connector); suitable for unleaded petrol and diesel oil. Operating pressure: 0,5 - 4 bar, flow rate: max. 80 l/min (water), viscosity: max. 7 mPas (cP), temperature: max. 60 °C

nominal-Ø	seal	outlet Ø	weight	part no.
G 1 male	NBR	21 mm	1,10 kg	10-001 12 097



## Longer outlet tube

220 mm long, Ø 20 mm

material	part no.
polypropylene	10-001 12 228
polyvinylidene fluoride	10-001 12 241
stainless steel	10-001 12 285



# Other pump accessories

## Adaptor

in PP for JUNIORFLUX/COMBIFLUX pumps  
to secure the pump in canisters or plastic drums

Ø canister-/drum bunghole	pump-Ø	part no.
45 mm	25 mm	10-001 14 069
45 mm	28 mm	10-001 14 070
45 mm	32 mm	10-001 14 071
65 mm	25 mm	10-001 14 072
65 mm	28 mm	10-001 14 073
65 mm	32 mm	10-001 14 074



## Compression gland

to secure the pump in the bunghole of the drum

### • Compression gland in PE

connection thread	pump-Ø	part no.
57 x 4 male	41 mm	10-001 14 067
70 x 6 male	41 mm	10-001 14 065
70 x 6 male	50 mm	10-001 14 066



### • Compression gland in PP electrically conductive

connection thread	pump-Ø	part no.
G 2 male	40/41 mm	10-001 14 054
G 2 male	50 mm	10-001 14 062
R2 male	25 mm	10-001 14 076
R2 male	28 mm	10-001 14 077
R2 male	32 mm	10-001 14 078



### • Compression gland in steel/zinc-plated

connection thread	pump-Ø	part no.
G 2 male/M 64 x 4	40 mm	10-001 14 061
G 2 male/M 64 x 4	41 mm	10-001 14 000
G 2 male	50 mm	10-001 14 003
M 64 x 4 male	50 mm	10-001 14 002



## Quick action coupling SSK 400

for a quick assembly of motor and drum pump. Consisting of: threaded ring (motor side) and clamping element (pump side). (For hazardous areas only allowed in combination with equipotential bonding on pump and motor)

	part no.
complete	10-001 10 802
threaded ring	10-001 10 800
clamping element	10-001 10 804



## Mixing tube

to use the drum pump F 430 as a mixer, with a few simple steps the outer tube of the pump can be replaced with the mixing tube, immersion length: 1.000 mm

material	pump-Ø	weight	part no.
aluminium (AL)	41 mm	0,73 kg	10-430 11 193
stainless steel (S)*	41 mm	1,64 kg	10-430 21 193
polypropylene (PP)	40 mm	0,42 kg	10-430 41 193



\*not allowed in hazardous areas

## FLUX fume gland

prevents emission of high aggressive fumes while pumping out of drums which can cause damage on human beings or the environment

The fume gland consists of a valve part and a threaded ring. For use with a drum pump.

- **Valve part in polypropylene (PP), o-ring in FKM**

	pump-Ø	part no.
with ball valve	25 mm	10-001 14 309
with ball valve	32 mm	10-001 14 313
with ball valve	40 mm	10-001 14 181
with ball valve	41 mm	10-001 14 182
with ball valve	50 mm	10-001 14 243

For use with a gas compensation hose, hose nozzle (10-959 13 128) is required.



- **Threaded ring in polypropylene (PP), flat seal in FKM**

connection thread	pump-Ø	part no.
G 2 male	25/32/40/41 mm	10-001 14 218
S 57 x 4 male	25/32/40/41 mm	10-001 14 224
S 60 x 6 female	25/32/40/41 mm	10-001 14 228
S 70 x 6 female	25/32/40/41 mm	10-001 14 226
S 70 x 6 male	25/32/40/41 mm	10-001 14 232
BCS 70 x 6 male	25/32/40/41 mm (with o-ring)	10-001 14 236
G 2 A male	50 mm	10-001 14 238
S 70 x 6 male	50 mm	10-001 14 267
S 70 x 6 female	50 mm	10-001 14 269
CC 64 x 5 male	40/41 mm	10-001 14 230
CCS 64 x 5 female	40/41 mm	10-001 14 271
CCS 64 x 5 male	50 mm	10-001 14 265



- **Valve part in stainless steel 316 Ti (S)**

	pump-Ø	part no.
with ball valve, o-ring FEP	41 mm	10-001 14 192
with ball valve, o-ring FEP	50 mm	10-001 14 253
o-ring FKM	28 mm	10-001 14 319
with gas compensation nozzle G 3/8	41 mm	10-001 14 194
with gas compensation nozzle G 3/8	50 mm	10-001 14 245



- **Threaded ring in stainless steel 316 Ti (S), flat seal in PE**

connection thread	pump-Ø	part no.
G 2 male	28/41 mm	10-001 14 325
S 57 x 4 male	28/41 mm	10-001 14 329
G 2 male	50 mm	10-001 14 331



- **Threaded ring in brass, nickel-plated (MS), flat seal in PE**

connection thread	pump-Ø	part no.
G 2 male	41 mm	10-001 14 327
G 2 male	50 mm	10-001 14 333

## Union joint hose

DN 10 (PP) for mounting onto valve part PP, S, MS when using a gas compensation nozzle

	part no.
G 1/4 male	10-959 13 128



## PE-corrugated hose

DN 10 for gas compensation hose

	part no.
outer-Ø 13 mm	10-001 10 061



## NBR-hose

for gas compensation hose, DN 10 electrically conductive

	part no.
outer-Ø 17mm	10-001 10 098



## Fume cone

PP, weight: 0,10 kg

	part no.
for longer outlet tube Ø 20 mm	10-001 14 285
for outlet Ø 24 mm	10-001 14 296



# Other pump accessories

## Discharge spout

for direct mounting onto the pump, outlet in order to allow the filling of adjacent containers and tanks

- with union nut G 1 female for use with **JUNIORFLUX**

material	nominal-Ø	weight	part no.
polypropylene (PP)	DN 19	0,03 kg	10-959 07 008

- with union nut G 1¼ female for use with **drum pumps**

material	nominal-Ø	weight	part no.
aluminium (AL)	DN 25	0,12 kg	10-959 07 003
stainless steel (S)	DN 25	0,38 kg	10-959 07 007
polypropylene (PP)	DN 19	0,04 kg	10-959 07 009



## Suction strainer

to protect the pump against coarse impurities. For mounting on the pump suction

material	pump-Ø	(suction strainer-Ø)	weight	part no.
polypropylene	40/41 mm	53 mm	0,03 kg	10-001 10 200
polypropylene	50 mm	60 mm	0,04 kg	10-001 10 205
polyvinylidene fluoride	40/41 mm	53 mm	0,04 kg	10-001 10 245
polyvinylidene fluoride	50 mm	60 mm	0,06 kg	10-001 10 267
stainless steel	41 mm	53 mm	0,17 kg	10-001 10 209
stainless steel	43 mm	53 mm	0,17 kg	10-001 10 294
	for use with F 424 S-43/38 and -43/37Z			
stainless steel	50 mm	60 mm	0,19 kg	10-001 10 212



## Inliner suction protection

for use with inliner, prevents the ingress of the inliner in the pump, material stainless steel (316 Ti)

pump-Ø	part no.
50 mm	10-001 10 347
54 mm	10-001 10 350



## Flowback stop valve

prevents the flow back of the liquid type stainless steel: connection thread: G 1¼ female – G 1¼ male

- for mounting onto the **drum pump** outlet of the **F 424 – F 430**

material	seal	weight	part no.
stainless steel	FKM	0,53 kg	10-959 14 024
stainless steel	FFKM	0,53 kg	10-959 14 048

- for mounting onto the **drum pump** foot of the **F 430 40/33**

material	weight	part no.
polypropylene	0,25 kg	10-959 14 029
polyvinylidene fluoride	0,28 kg	10-959 14 038

- for mounting onto the **drum pump** foot of the **F 430 40/33 Z**

material	weight	part no.
polypropylene	0,25 kg	10-959 14 030
polyvinylidene fluoride	0,28 kg	10-959 14 039



## By-pass valve

for eccentric worm-drive pumps. Safety valve against possibly upcoming overpressure in the pump system, connection thread G 1½ female – G 1½ male for mounting onto the outlet, range of setting: stainless steel (316 Ti): 4 – 6 bar, brass: 2 – 8 bar

material, seal	connection	weight	part no.
brass, PTFE	flow back tube 300 mm long	3,10 kg	10-001 18 026
brass, PTFE	hose connection DN 19	2,70 kg	10-001 18 028
stainless steel, FKM	flow back tube 300 mm long	2,30 kg	10-001 18 027
stainless steel, FKM	hose connection DN 19	1,90 kg	10-001 18 029
stainless steel, PTFE	hose connection DN 19	1,90 kg	10-001 18 046
brass, PTFE	hose connection DN 25	1,90 kg	10-001 18 056
stainless steel, FKM	hose connection DN 25	1,90 kg	10-001 18 057
stainless steel, PTFE	hose connection DN 25	1,90 kg	10-001 18 058





## Attachment clamp

to securely the pump in open containers or drums material: steel/zinc-plated, PP

pump-Ø	weight	part no.
40/41 mm	0,84 kg	10-001 10 601
50 mm	0,84 kg	10-001 10 603
54 mm	0,84 kg	10-001 10 604



## Container clip

to suspend the pump into open containers

material	pump-Ø	weight	part no.
aluminium (AL),	40/41 mm	0,12 kg	10-001 15 005
PVC coated	50 mm	0,14 kg	10-001 15 006



## Mounting flange

acc. to DIN 2501 for stationary installation of the drum pump. The flange is welded onto the outer tube of the pump, dimensions: outer-Ø 165 mm, pitch circle-Ø 125 mm, bores 4 x 18 mm

material	weight	part no.
polypropylene	0,37 kg	10-947 14 021
polyvinylidene fluoride	0,70 kg	10-947 14 034
stainless steel 1.4571*	1,50 kg	10-947 14 033



\* not allowed with stainless steel pumps which are used in hazardous areas.

## Wall bracket

for secure storage of the pump. Incl. fixing screws

pump	weight	part no.
drum pumps F 424 – F 430	0,37 kg	10-001 10 426



## Hoist

with infinitely adjustable load balancer

carrying force	rope length	weight	part no.
9 – 14 kg	2 m	3,75 kg	10-001 21 000
16 – 21 kg	2 m	4,15 kg	10-001 21 002



## Carrying handle

allowing easy immersion and removal of the pump.

- for pumps with commutator motor, steel, painted in black

for motor	weight	part no.
F 457	0,35 kg	10-001 10 533
F 458, F 458-1, F 460 Ex, F 460-1 Ex FBM 4000 Ex	0,35 kg	10-001 10 557

- for pumps with three-phase gearmotor, steel, painted in black

	weight	part no.
Motor F 414	0,37 kg	10-001 10 582

- for pumps with single-phase AC-motor, three-phase motor or air motor  
carrying handle will be connected to the pump by screws.

motor	flange	weight	part no.
AC-motor F 403	Ø 120	0,85 kg	10-001 10 584
3-phase motor F 403 Ex	Ø 120	1,10 kg	10-001 10 587
3-phase motor up to 3 kW	Ø 160	1,20 kg	10-001 10 571
3-phase motor up to 4 kW	Ø 160	1,30 kg	10-001 10 531
Ex-proof 3-phase motor up to 3,3 kW	Ø 160	1,30 kg	10-001 10 586
air motor FPM 2-8 Ex	Ø 160	1,00 kg	10-001 10 520

- for motor flange Ø 160, stainless steel, separate fixation of pump and motor – single disconnection of the pump is possible, motor stays at the carrying handle.

motor	weight	part no.
for 3-phase motor up to 4 kW	1,70 kg	10-001 10 590



# Accessories for drive motors

## Earth (ground) wire with crocodile clip

for electrically bonding the explosion-proof pump to the container. For equipotential bonding

colour	cable cross-section	weight	length	forceps	part no.
yellow	3 mm <sup>2</sup>	0,52 kg	4 m	Edelstahl	10-931 90 023
green/yellow	4 mm <sup>2</sup>	0,15 kg	2 m	Stahl	10-931 90 015



## Motor protection switch

prevents the three-phase motor from overload.

The ranges of setting apply to 400 Volt only.

- not for use in hazardous areas, fixation on motor is possible, protected to IP 65, weight: 0,85 kg

range of setting	part no.
0,85 – 1,35 A	10-936 06 167
1,30 – 2,00 A	10-936 06 168
1,80 – 3,00 A	10-936 06 169
2,80 – 4,60 A	10-936 06 170
4,20 – 6,70 A	10-936 06 171
6,50 – 10,00 A	10-936 06 172
10,00 – 16,00 A	10-936 06 173



- Explosion-proof motor protection switch**

explosion-proof to II2 EEx de IIC T6 protected to IP 65, for mounting on carrying handle or wall, weight: 2,64 kg

range of setting	part no.
1,0–1,6 A	10-936 06 137
1,6–2,5 A	10-936 06 118
2,5–4,0 A	10-936 06 119
4,0–6,5 A	10-936 06 120



## Power supply cable

for three-phase motors

	weight	part no.
per meter	0,26 kg/m	10-934 08 901
pre-assembled with sleeve <b>without plug</b> , 5 m long	1,30 kg	10-934 08 025
pre-assembled <b>with sleeve and Cekon plug</b> , 5 m long	1,42 kg	10-934 08 020
cable assembly to motor, switch or connector		10-000 00 250



## Cekon plug

5-pole

	weight	part no.
without phase changing switch	0,14 kg	10-937 01 014
with phase changing switch	0,20 kg	10-937 01 035



## Explosion-proof plug

3-pole CEE-type plug, explosion-proof to II 2 G EEx de IIC T6, 220-240 Volt, protected to IP 65

system	weight	part no.
CEAG	0,35 kg	10-937 01 030
Stahl	0,27 kg	10-937 01 018



## Explosion-proof socket

3-pole CEE-type socket, explosion-proof to II 2 G EEx de IIC T6, 220-240 Volt, protected to IP 65

system	weight	part no.
CEAG	0,95 kg	10-937 50 041
Stahl	0,92 kg	10-937 50 022



## Explosion-proof plug

5-pole CEE-type plug, explosion-proof to II 2 G EEx de IIC T6, 380-415 Volt, protected to IP 65

system	weight	part no.
CEAG	0,35 kg	10-937 01 029
Stahl	0,27 kg	10-937 01 020



## Explosion-proof socket

5-pole CEE-type socket, explosion-proof to II 2 G EEx de IIC T6, 380-415 Volt, protected to IP 65

system	weight	part no.
CEAG	0,95 kg	10-937 50 040
Stahl	0,92 kg	10-937 50 024



## Filter-regulator-lubricator unit

for compressed air motors type F 416 Ex, F 416-1 Ex, F 416-2 Ex and FPM 4-8 Ex; for air conditioning and regulation of the operating pressure. Consisting of: water separator, pressure gauge and lubricator. Female thread on inlet and outlet

connection	weight	part no.
G ¼ female – G ¼ female (F416..Ex)	0,75 kg	10-001 10 100
G ½ female – G ½ female (FPM..Ex)	1,90 kg	10-001 10 103



## Fine filter sound absorber

with oil separator for noise reduction

	weight	part no.
type FS 3	0,57 kg	10-947 15 003
fixing element	0,1 kg	10-947 15 004



## Exhaust air hose kit for fine filter

consisting of:	part no.
5 m PVC hose, 2 x hose nozzle, 2 x flat seal, 2 x 1-ear-clip	10-001 10 886

## Pressure regulator

	connection	part no.
FDM 06 / 10 / 12 / 25	G ¼ female	10-001 10 101
FDM 25 / 40 / 50 / 80	G ½ female	10-001 10 102



# Accessories for FOOD version

Accessories for drum pumps and eccentric worm-drive pumps in FOOD version suitable for food contact according to Regulation (EC) 1935/2004 and FDA CFR 21

## Hose connection

material: stainless steel

clamp	nominal-Ø	seal	part no.
1½"	DN 19	FKM	10-959 04 171
1½"	DN 19	NBR	10-959 04 172
1½"	DN 25	FKM	10-959 04 169
1½"	DN 25	NBR	10-959 04 170
2"	DN 32	FKM	10-959 04 173
2"	DN 32	NBR	10-959 04 174
2"	DN 38	FKM	10-959 04 175
2"	DN 38	NBR	10-959 04 176

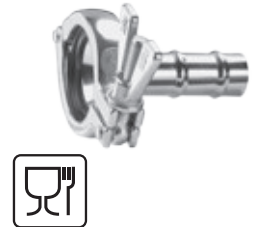

## Swaged hose fitting

for the connection of pump and hose suitable for for hose for food and chemistry, spezial hose for food and chemistry. Screw-on type, material: stainless steel

clamp	nominal-Ø	seal	part no.
1½"	DN 19	FKM	10-959 13 354
1½"	DN 19	NBR	10-959 13 355
1½"	DN 25	FKM	10-959 13 356
1½"	DN 25	NBR	10-959 13 357
2"	DN 25	FKM	10-959 13 358
2"	DN 25	NBR	10-959 13 359
2"	DN 32	FKM	10-959 13 360
2"	DN 32	NBR	10-959 13 361
2"	DN 38	FKM	10-959 13 362
2"	DN 38	NBR	10-959 13 363

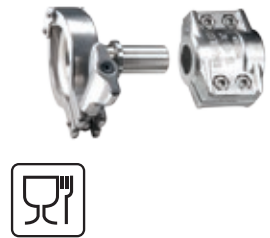

## Discharge spout

material: stainless steel

clamp	seal	part no.
1½"	FKM	10-959 07 030
1½"	NBR	10-959 07 033
2"	FKM	10-959 07 034
2"	NBR	10-959 07 035



## Flap valve

material: stainless steel

clamp	nominal-Ø	seal	part no.
1½"	DN 38	NBR	10-959 19 006
1½"	DN 38	FKM	10-959 19 004
2"	DN 50	FKM	10-959 19 005
2"	DN 50	NBR	10-959 19 007



## Hand nozzle

for use in connection with FLUX drum pump FP 430 Ex S FOOD for alcohol material: stainless steel, outlet Ø 28 mm

clamp	seal	part no.
1½"	PTFE/FKM	10-001 12 568





A series of horizontal dotted lines spanning the width of the page, intended for taking notes.



A series of horizontal dotted lines spanning the width of the page, intended for taking notes.



More than just pumps

FLUX is a world renowned brand for the highest standards in pump technology. It all began in 1950 with the invention of the electric drum pump. Today, FLUX offers a wide range of products which can be configured individually. For example, FLUX pumps are used in the chemical and pharmaceutical industries, in machine and plant construction, as well as in electroplating, sewage treatment plants, and the food industry.

Whether as a stand-alone or a system solution, FLUX quality means long useful life, excellent economic efficiency and a maximum of safety.

Apart from the outstanding FLUX product quality and reliability, our clients appreciate the expertise and dedication of our employees to customer service.

Today, FLUX-GERÄTE GMBH supplies pumps to almost one hundred countries world wide.